

TOOL HOLDERS

VDI Coolant

VDI Coolant

VDI 内冷型

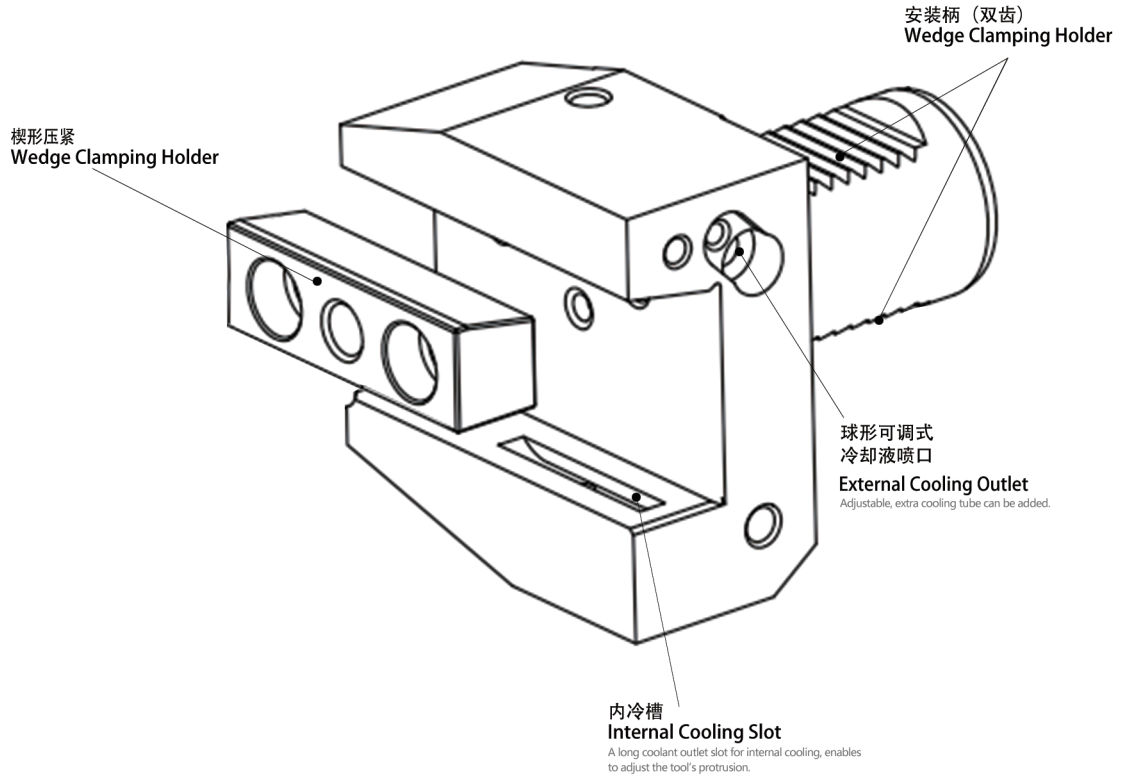

VDI COOLANT TOOLING SYSTEM

VDI COOLANT 工具系统

B1A Radial, Coolant.....	004
短型横向右刀夹, 内冷型.....	004
B2A Radial, Coolant.....	005
短型横向左刀夹, 内冷型.....	005
B3A Radial, Short, Coolant	006
短型横向反切右刀夹, 内冷型.....	006
B4A Radial, Short, Coolant	007
短型横向反切左刀夹, 内冷型.....	007
B1B4A Radial, Coolant.....	008
短型横向右(反切左)刀夹, 内冷型.....	008
B1B4AK Coolant, Wedge Clamping.....	009
短型横向右(反切左)刀夹, 内冷型, 楔形压紧.....	009
B2B3A Radial, Short, Coolant.....	010
短型横向左(反切右)刀夹, 内冷型.....	010
B2B3AK Coolant, Wedge Clamping.....	011
短型横向左(反切右)刀夹, 内冷型, 楔形压紧.....	011
B5AK Radial, Long, Coolant, Wedge Clamping Holders	012
长型横向右刀夹, 内冷型, 楔形压紧.....	012
B6AK Radial, Long, Coolant, Wedge Clamping Holders	013
长型横向左刀夹, 内冷型, 楔形压紧.....	013
B7AK Radial, Long, Coolant, Wedge Clamping Holders	014
长型横向反切右刀夹, 内冷型, 楔形压紧.....	014
C1C4A Axial, Coolant.....	015
纵向右(反切左)刀夹, 内冷型.....	015
C1C4AK Coolant, Wedge Clamping.....	016
纵向右(反切左)刀夹, 内冷型, 楔形压紧.....	016
C2C3A Axial, Coolant.....	017
纵向左(反切右)刀夹, 内冷型.....	017
C2C3AK Coolant, Wedge Clamping	018
纵向左(反切右)刀夹, 内冷型, 楔形压紧.....	018
D1D2A Rectangular Holder, Coolant.....	019
多座刀夹, 内冷型.....	019
ARALU Cuting Off Tool Holder, Coolant.....	020
短型横向切刀右(反切左)刀夹, 内冷型.....	020
ALARU Cuting Off Tool Holder, Coolant.....	021
短型横向切刀左(反切右)刀夹, 内冷型.....	021
Unterlegplatte.....	022
垫片.....	022

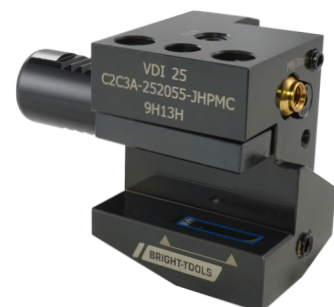

VDI

B1A Radial, Short, Coolant 短型横向右刀夹, 内冷型

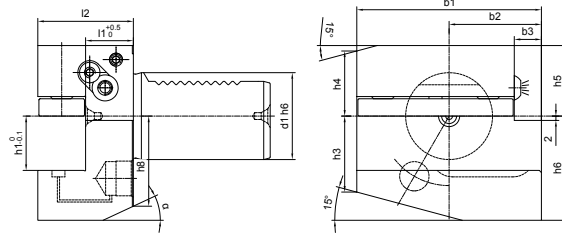

Size	b1	b2	b3	l1	h3	h4	h5	h6	h8	α
B1A-161234	42	23	5	23	15	15	20	22	19	30°
B1A-201640	55	30	7	26	19	19	25	30	23	30°
B1A-252040	70	35	10	22	26	22	28	38	30	25°
B1A-302040	70	35	10	22	26	22	28	38	30	25°
B1A-402544	85	42.5	12.5	22	35	30	32.5	48	43	30°
B1A-502544	85	42.5	12.5	22	43	30	32.5	48	43	30°

B2A Radial, Short, Coolant 短型横向左刀夹，内冷型

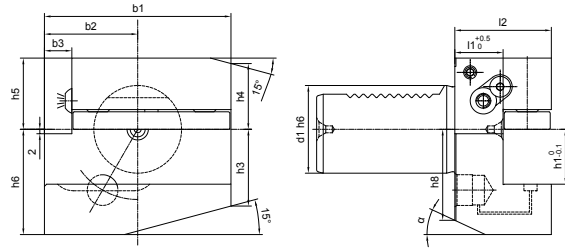

Size	b1	b2	b3	l1	h3	h4	h5	h6	h8	a
B2A-161234	42	23	5	23	15	15	20	22	19	30°
B2A-201640	55	30	7	26	19	19	25	30	23	30°
B2A-252040	70	35	10	22	29.5	22	28	38	30	25°
B2A-302040	70	35	10	22	26	22	28	38	30	25°
B2A-402544	85	42.5	12.5	22	35	30	32.5	48	43	30°
B2A-502544	85	42.5	12.5	22	35	30	32.5	48	43	30°

B3A Radial, Short, Coolant 短型横向反切右刀夹, 内冷型

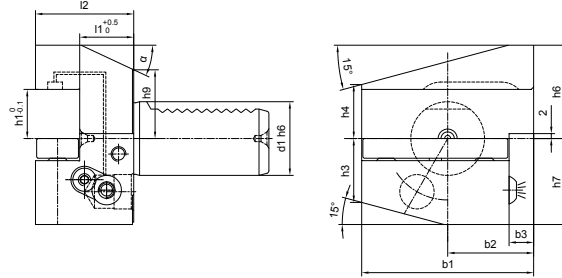
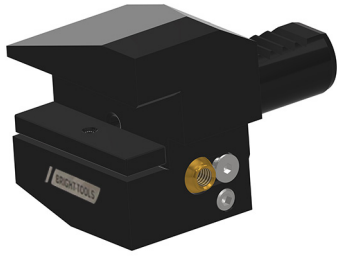

Size	b1	b2	b3	l1	h3	h4	h6	h7	h9	α
B3A-161234	42	23	5	23	15	15	22	20	19	30°
B3A-201640	55	30	7	26	19	19	30	25	23	30°
B3A-302040	70	35	10	22	26	22	38	35	28	25°
B3A-402544	85	42.5	12.5	22	35	30	48	42.5	43	30°
B3A-502544	85	42.5	12.5	22	35	30	48	42.5	43	30°

B4A Radial, Short, Coolant
短型横向反切左刀夹, 内冷型

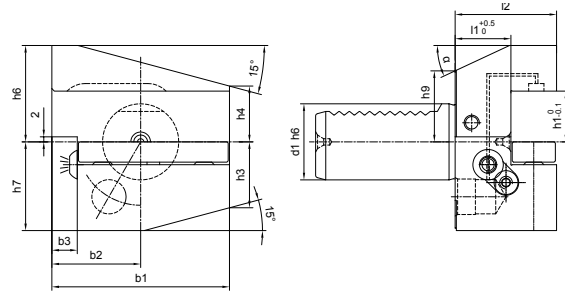

Size	b1	b2	b3	l1	h3	h4	h6	h7	h9	α
B4A-161234	42	23	5	23	15	15	22	20	19	30°
B4A-201640	55	30	7	26	19	19	30	25	23	30°
B4A-302040	70	35	10	22	26	22	38	35	28	25°
B4A-402544	85	42.5	12.5	22	35	30	48	42.5	43	30°
B4A-502544	85	42.5	12.5	22	35	30	48	42.5	43	30°

B1B4A Radial, Short, Coolant 短型横向右 (反切左) 刀夹, 内冷型

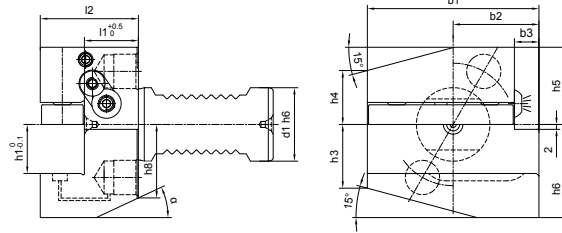

Size	b1	b2	b3	l1	h3	h4	h5	h6	h8	α
B1B4A-302040	70	35	10	22	26	22	31.5	38	30	25°
B1B4A-402544	85	42.5	12.5	22	35	30	38	48	43	30°
B1B4A-502544	85	42.5	12.5	22	43	30	43	48	43	30°

B1B4AK Radial, Short, Coolant, Wedge Clamping Holders

短型横向右 (反切左) 刀夹, 内冷型, 楔形压紧

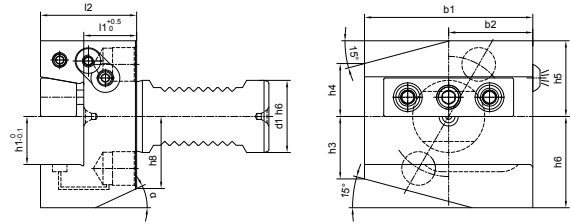

Size	b1	b2	b3	l1	h3	h4	h5	h6	h8	α
B1B4AK-302040	70	35	-	22	26	22	31.5	38	30	25°
B1B4AK-402544	85	42.5	-	22	35	30	38	48	43	30°
B1B4AK-502544	85	42.5	-	22	43	30	43	48	43	30°

B2B3A Radial, Short, Coolant 短型横向左 (反切右) 刀夹, 内冷型

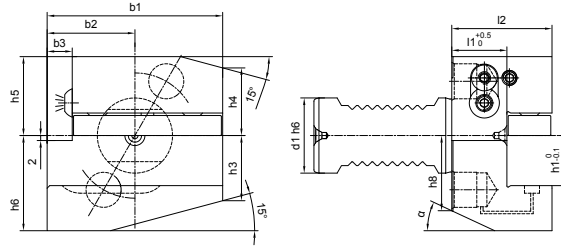

Size	b1	b2	b3	l1	h3	h4	h5	h6	h8	α
B2B3A-302040	70	35	10	22	26	27	31.5	38	30	25°
B2B3A-402544	85	42.5	12.5	22	35	30	38	48	43	30°
B2B3A-502544	85	42.5	12.5	22	35	38	43	48	43	30°

B2B3AK Radial, Short, Coolant, Wedge Clamping Holders

短型横向左 (反切右) 刀夹, 内冷型, 楔形压紧

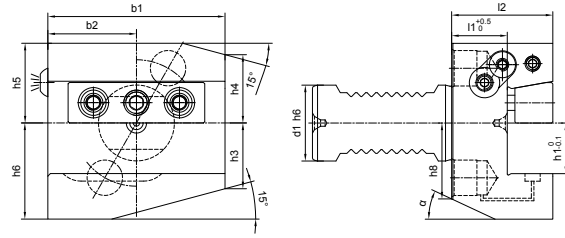

Size	b1	b2	b3	l1	h3	h4	h5	h6	h8	α
B2B3AK-302040	70	35	-	22	26	27	31.5	38	30	25°
B2B3AK-402544	85	42.5	-	22	35	30	38	48	43	30°
B2B3AK-502544	85	42.5	-	22	35	38	43	48	43	30°

B5AK Radial, Long, Coolant, Wedge Clamping Holders

长型横向右刀夹, 内冷型, 楔形压紧

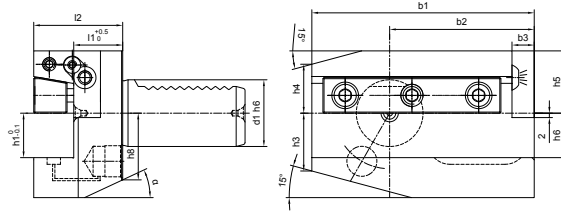

Size	b1	b2	b3	l1	h3	h4	h5	h6	h8	α
B5AK-302040	100	65	10	22	26	22	28	38	30	25°
B5AK-402544	118	75.5	12.5	22	35	30	32.5	48	43	30°
B5AK-503255	130	80	16	30	42	35	35	60	43	30°
B5AK-603260	145	82.5	16	30	46	42.5	42.5	62.5	43	30°

B6AK Radial, Long, Coolant, Wedge Clamping Holders

长型横向左刀夹, 内冷型, 楔形压紧

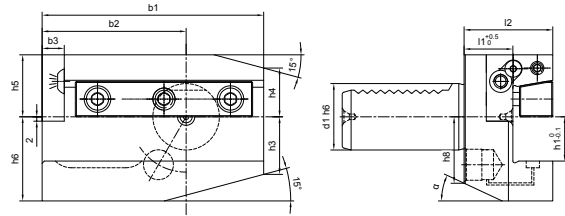

Size	b1	b2	b3	l1	h3	h4	h5	h6	h8	α
B6AK-302040	100	65	10	22	26	22	28	38	30	25°
B6AK-402544	118	75.5	12.5	22	35	30	32.5	48	43	30°
B6AK-503255	130	80	16	30	42	35	35	60	55	30°
B6AK-603260	145	82.5	16	30	46	42.5	42.5	62.5	57	30°

B7AK Radial, Long, Coolant, Wedge Clamping Holders

长型横向反切右刀夹, 内冷型, 楔形压紧

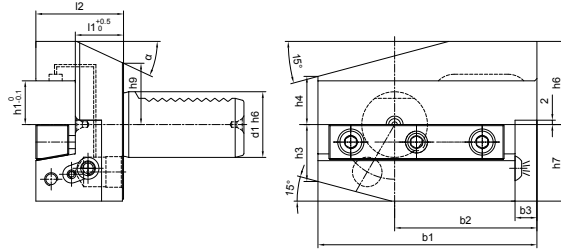

Size	b1	b2	b3	l1	h3	h4	h6	h7	h9	α
B7AK-302040	100	65	10	22	26	22	38	35	28°	25°
B7AK-402544	118	75.5	12.5	22	35	30	48	42.5	43	30°
B7AK-503255	130	80	16	30	42	35	60	50	55	30°
B7AK-603260	145	82.5	16	30	46	42.5	62.5	62.5	57	30°

C1C4A Axial, Coolant
纵向右 (反切左) 刀夹, 内冷型

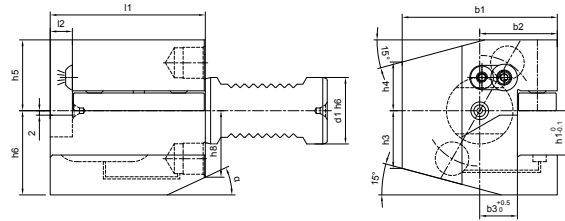

Size	b1	b2	b3	l2	h3	h4	h5	h6	h8	a
C1C4A-161244	43	24	13	5	15	15	24	20	19	30°
C1C4A-201655	52	27	13	7	19	19	25	30	23	30°
C1C4A-252025	58	33	15	7	26	26	28	36	28	15°
C1C4A-302070	70	35	17	10	26	22	32	38	30	25°
C1C4A-402585	85	42.5	21	12.5	35	30	38	48	40	15°
C1C4A-502585	90.5	48	26	12.5	42	35	44	48	43	30°

C1C4AK Axial, Coolant, Wedge Clamping Holders

纵向右 (反切左) 刀夹, 内冷型, 楔形压紧

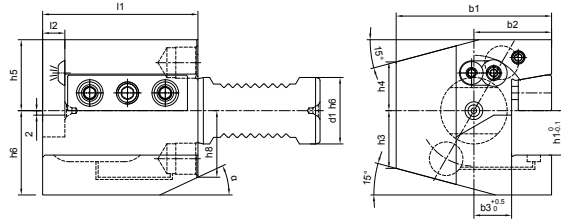

Size	b1	b2	b3	l2	h3	h4	h5	h6	h8	α
C1C4AK-302070	70	35	17	10	26	22	32	38	30	25°
C1C4AK-402585	85	42.5	21	12.5	35	30	38	48	40	15°
C1C4AK-502585	90.5	48	26	12.5	42	35	44	48	43	30°

C2C3A Axial, Coolant
纵向左 (反切右) 刀夹, 内冷型

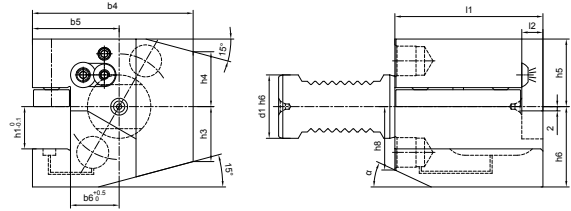

Size	b4	b5	b6	l2	h3	h4	h5	h6	h8	α
C2C3A-161244	43	24	13	5	15	15	20	24	19	30°
C2C3A-201655	58	33	19	7	19	19	25	30	23	30°
C2C3A-252055	62	37	19	7	26	26	28	36	28	15°
C2C3A-302070	76	41	23	10	26	26	32	38	30	25°
C2C3A-402585	90	47.5	25.5	12.5	35	30	38	48	40	15°
C2C3A-502585	95	52.5	30.5	12.5	42	37	44	48	43	30°

C2C3AK Axial, Coolant, Wedge Clamping Holders

纵向左 (反切右) 刀夹, 内冷型, 楔形压紧

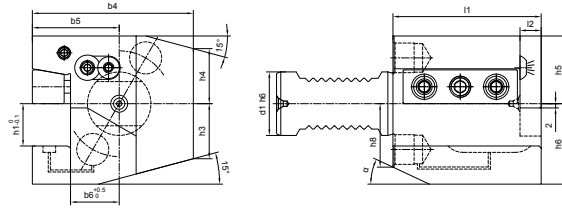

Size	b4	b5	b6	l2	h3	h4	h5	h6	h8	α
C2C3AK-302070	76	41	23	10	26	26	32	38	30	25°
C2C3AK-402585	90	47.5	25.5	12.5	35	30	38	48	40	15°
C2C3AK-502585	95	52.5	30.5	12.5	42	37	44	48	43	30°

D1D2A Rectangular Holder, Coolant 多座刀夹, 内冷型

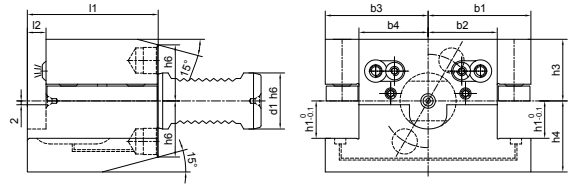
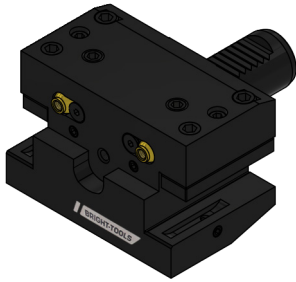

Size	b1	b2	b3	b4	h3	h4	h6	l2	α
D1D2A-252055	37	19	37	19	28	38	28	7	15°
D1D2A-302070	55	37	55	37	33	38	30	10	15°
D1D2A-402585	65	43	65	43	43.5	48	37	12.5	15°

ARALU Cutting Off Tool Holder, Coolant 短型横向切刀右 (反切左) 刀夹, 内冷型

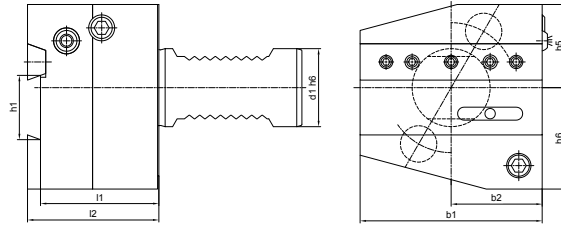

Size	l1	l2	b1	b2	h5	h6
ARALUA-2526	44	50	60	30	28	36
ARALUA-3026	44	50	70	35	32	37
ARALUA-3032	44	50	85	42.5	32	40
ARALUA-4026	44	50	85	42.5	43	40
ARALUA-4032	44	50	85	42.5	43	40
ARALUA-5032	44	50	100	50	43	45

ALARU Cutting Off Tool Holder, Coolant
短型横向切刀左 (反切右) 刀夹, 内冷型

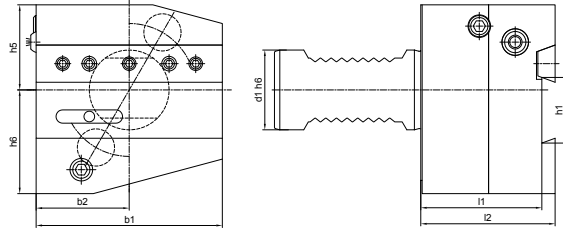

Size	l1	l2	b1	b2	h5	h6
ALARUA-2526	44	50	60	30	28	36
ALARUA-3026	44	50	70	35	32	37
ALARUA-3032	44	50	85	42.5	32	40
ALARUA-4026	44	50	85	42.5	43	40
ALARUA-4032	44	50	85	42.5	43	40
ALARUA-5032	44	50	100	50	43	45

Unterlegplatte

垫片

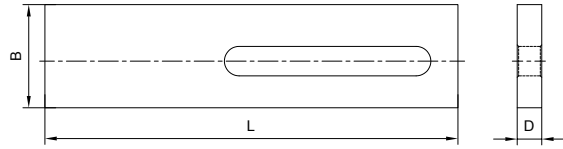

Size	L	B	D
36x10x4	36	10	4
47x13x5	47	13	5
59x17x8	59	17	8
71.5x21x8	71.5	21	8